

## SS5T12B

### 5.0AMPS. SCHOTTKY BARRIER RECTIFIERS

#### FEATURE

- . For surface mounted application
- . High current capability,
- . Low forward voltage drop
- . Low power loss, high efficiency
- . High surge current capability
- . High temperature soldering guaranteed  
260°C/10 seconds at terminals.
- . For surface mounted application.
- . Easy pick and place.

#### MECHANICAL DATA

- . Terminal: Solder plated
- . Case: Molded with UL-94 Class V-0 recognized  
Flame Retardant Epoxy
- . Polarity: color band denotes cathode
- . Packaging: 12mm tape per EIA STD RS-481

#### SMB (DO-214AA)

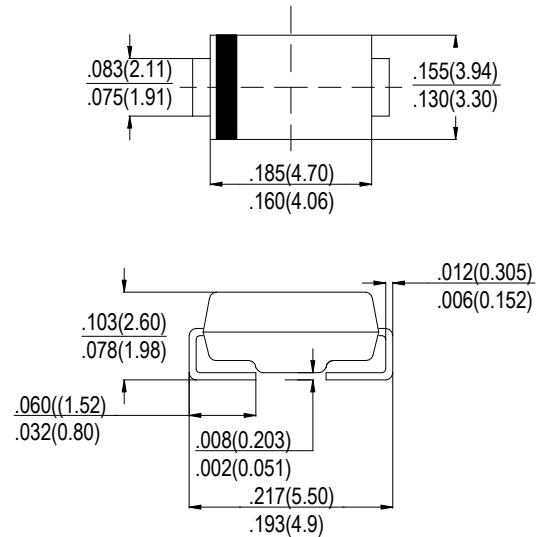

Dimensions in inches and (millimeters)

#### MAXIMUM RATINGS AND ELECTRICAL CHARACTERISTICS

Ratings at 25°C ambient temperature unless otherwise specified.

Single phase, half wave, 60Hz, resistive or inductive load.

For capacitive load, derate current by 20%

Type Number	SYM BOL	SS5T12B	units
Maximum Recurrent Peak Reverse Voltage	$V_{RRM}$	120	V
Maximum RMS Voltage	$V_{RMS}$	84	V
Maximum DC blocking Voltage	$V_{DC}$	120	V
Maximum Average Forward Rectified Current	$I_{F(AV)}$	5.0	A
Peak Forward Surge Current 8.3ms single half sine-wave superimposed on rated load (JEDEC method)	$I_{FSM}$	120	A
Maximum Forward Voltage at 5.0A DC	$V_{F Max}$	0.65	V
Maximum DC Reverse Current @ $T_J=25^{\circ}C$ at rated DC blocking voltage @ $T_J=100^{\circ}C$	$I_R$	0.1 10.0	mA
Typical Junction Capacitance (Note1)	$C_J$	670	pF
Typical Thermal Resistance (Note2)	$R_{(JA)}$	40	°C/W
	$R_{(JC)}$	16	
Storage Temperature	$T_{STG}$	-55 to +150	°C
Operating Junction Temperature	$T_J$	-55 to +150	°C

#### Note:

1. Measured at 1.0 MHz and applied reverse voltage of 4.0Vdc
2. Measured on P.C.Board with 0.2×0.2”(5.0×5.0mm)Copper Pad Areas.

**RATING AND CHARACTERISTIC CURVES (SS5T12B)**

FIG.1-TYPICAL FORWARD CURRENT DERATING CURVE

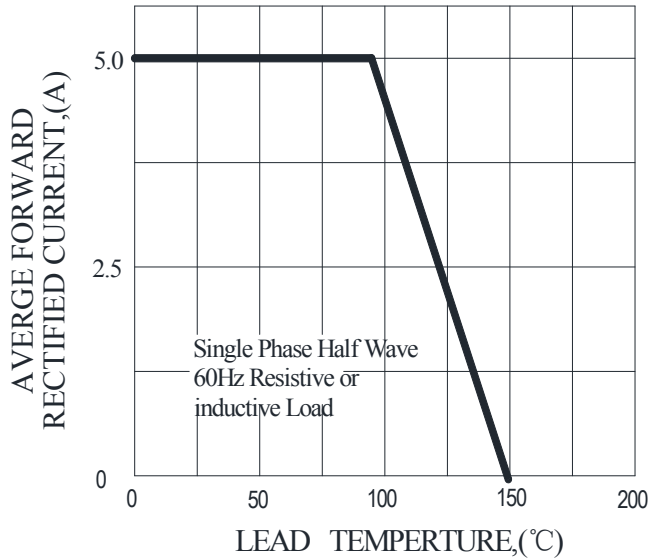

FIG.2-TYPICAL INSTANTANEOUS FORWARD CHARACTERISTICS

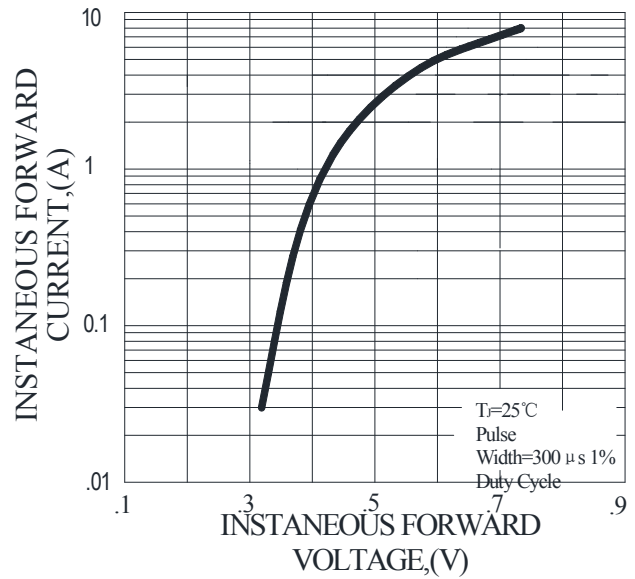

FIG.3-MAXIMUM NON-REPETITIVE FORWARD SURGE CURRENT

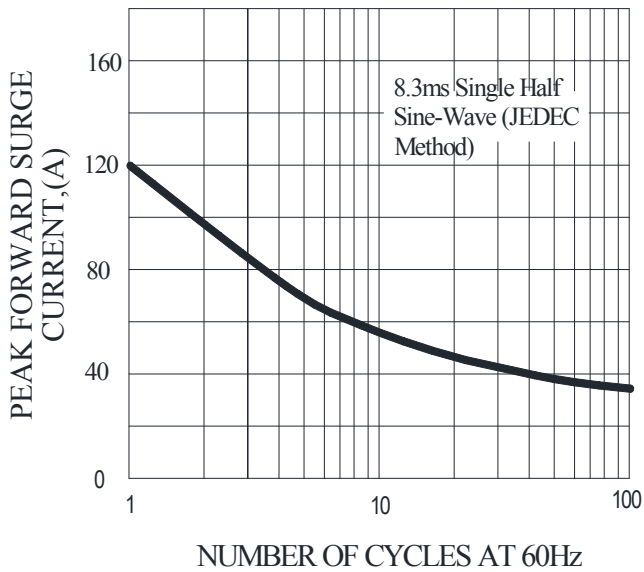
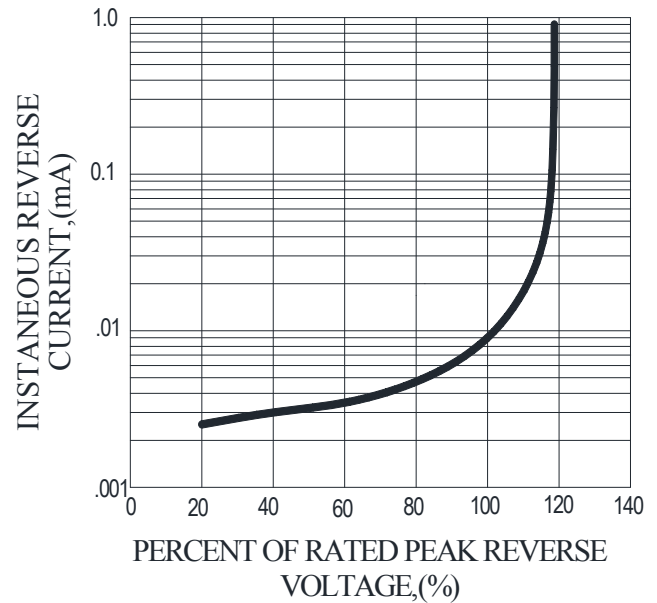
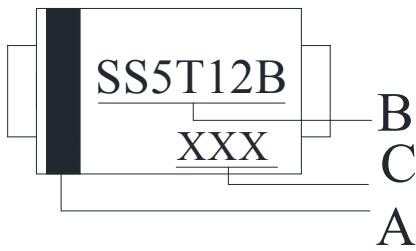

FIG.4-TYPICAL REVERSE CHARACTERISTICS



## Marking and packaging illustration

### 1、Marking



SYMBOL	Explanation
A	Color Band Denotes Cathode
B	Product Name
C	Date Code

### 2、Packaging

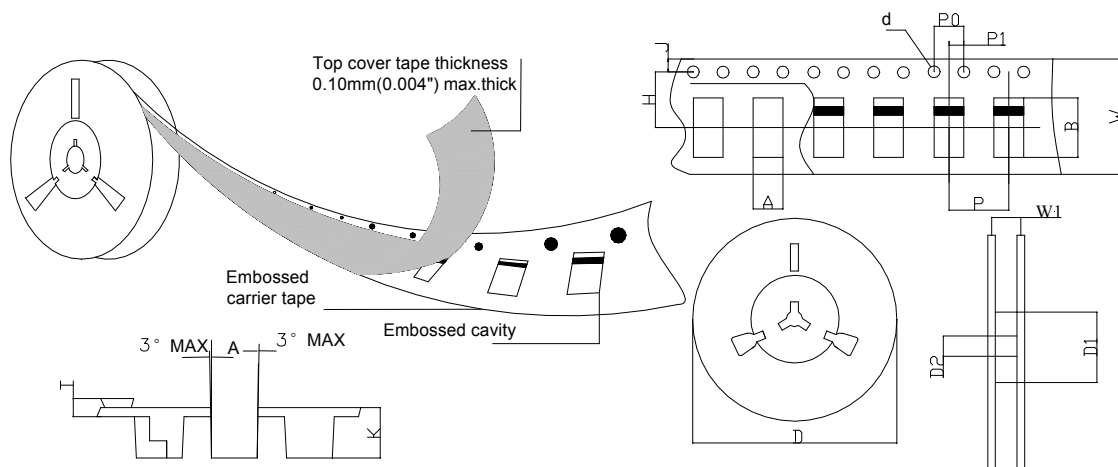

SPECIFICATIONS mm(inch)		PACKAGE
SYMBOL		SMB(DO-214AA)
ITEM		
Carrier width	A	3.81(0.150)Max
Carrier length	B	5.41(0.213)Max
Sprocket hole	d	ø1.55(0.061)Typ
Reel outer diameter	D	330.0(13.0)Typ
Reel inner diameter	D1	50.0(1.969)Min
Feed hole diameter	D2	13.0(0.512)Typ
Sprocket hole position	J	1.75(0.069)Typ
Punch hole position	H	5.55(0.219)Typ
Carrier depth	K	2.45(0.965)Typ
Punch hole pitch	P	8.00(0.315)Typ
Sprocket hole pitch	P0	4.00(0.157)Typ
Embossment center	P1	2.00(0.079)Typ
Overall tape thickness	T	0.30(0.012)Typ
Tape width	W	12.0(0.472)Typ
Reel width	W1	12.4(0.488)Min